

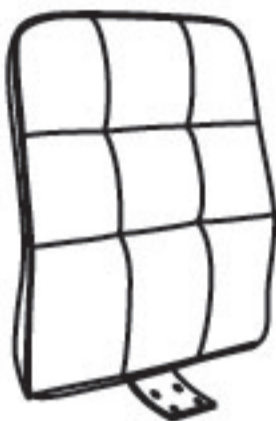







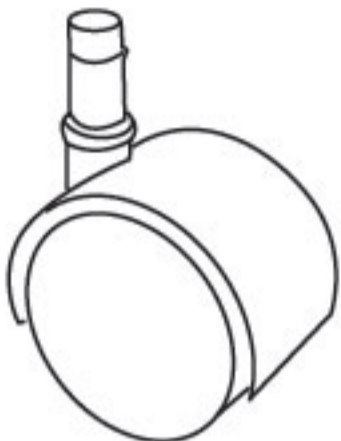

(1)x1	(2)x1	(3)x5
		
BACK	SEAT	CASTERS
(4)x1 (L)x1 (R)	(5)x1	(6)x1
		
LARM LEFT ARM RARM RIGHT ARM	GAS LIFT	BASE
(7)x1		
	<p>(A)x4  M8*22 MECHANISM SCREW</p> <p>(B)x4  M8*30 L-BAR SCREW</p> <p>(C)x8  M6*22 ARM SCREW</p>	
MECHANISM		

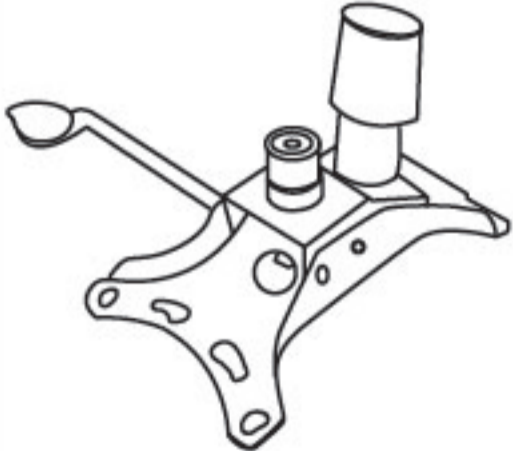

Insert and loosely tighten all screws. When assembly is completed, fully tighten all screws before using. This chair is only intended for sitting. Any other use will void the warranty.

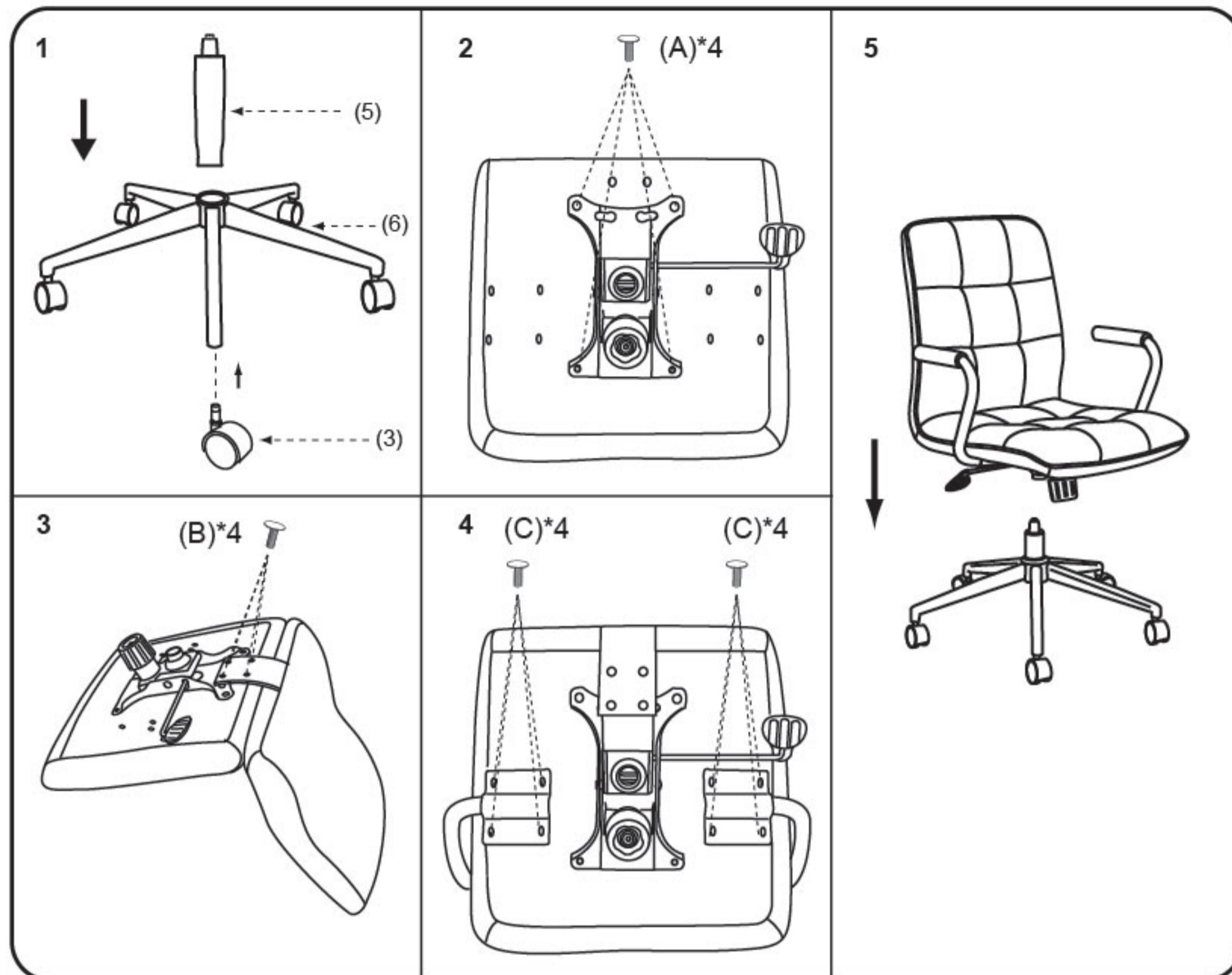

Teknik Office Ltd, West One 63-67 Bromham Road,
Bedford, MK40 2FG

TEL:01234 328804 FAX:01234 342446

If you encounter any problems with the operation of your chair, please refer to the downloads section of our web site - www.teknikoffice.co.uk